

CURB SIDE

COMPT.	INTERIOR HEIGHT	PASS-THRU HEIGHT	INTERIOR WIDTH	PASS-THRU WIDTHS	DEPTH	DESCRIPTION
P1	56"	55"	22"	19 1/2"	26"	IS/OS STORAGE
P2	12"	11"	20"	18 1/2"	19 1/4"	BATTERY TRAY
P3	72 1/4"	82 1/2"	34 1/2"	30"	---	SIDE ENTRY DOOR
P4	80 1/2"	79 1/2"	21 1/2"	17"	20 7/8"	BB/STAIR CHAIR STORAGE

DRAWING NO:  
**5294-SDE**

DRAWN BY: J.P.

DATE: 4/29/22

SCALE: 1"=32"

REVISION(S):  
---



**LIFE LINE**  
EMERGENCY VEHICLES

1 Life Line Dr. P.O. Box 299  
Sumner, IA 50674 Sumner, IA 50674

**FOR DRAWING APPROVAL**

APPROVED BY: \_\_\_\_\_

TITLE: \_\_\_\_\_

DATE: \_\_\_\_\_

**167" TYPE III SUPERLINER, 72" HEADROOM  
FOR GORMAN EMERGENCY VEHICLES DEMO**

DIMENSIONS SHOWN ARE APPROXIMATE AND MAY CHANGE DURING THE CONSTRUCTION PROCESS. PRINTS ARE FOR GRAPHICAL REPRESENTATION ONLY AND NOT FOR DESIGN PURPOSES.

Tolerances:  
Third Angle Projection (ANSI)

Ang. Tol: ±1°  
Dim. Tol: ±1/16"

THIS DRAWING IS THE PROPERTY OF LIFE LINE EMERGENCY VEHICLES, WHICH CLAIMS PROPRIETARY RIGHTS IN THE MATERIAL DISCLOSED. IT IS ISSUED IN CONFIDENCE FOR ENGINEERING INFORMATION ONLY AND MAY NOT BE COPIED OR USED FOR MANUFACTURING OF ANYTHING SHOWN WITHOUT SPECIFIC WRITTEN PERMISSION OF LIFE LINE EMERGENCY VEHICLES.

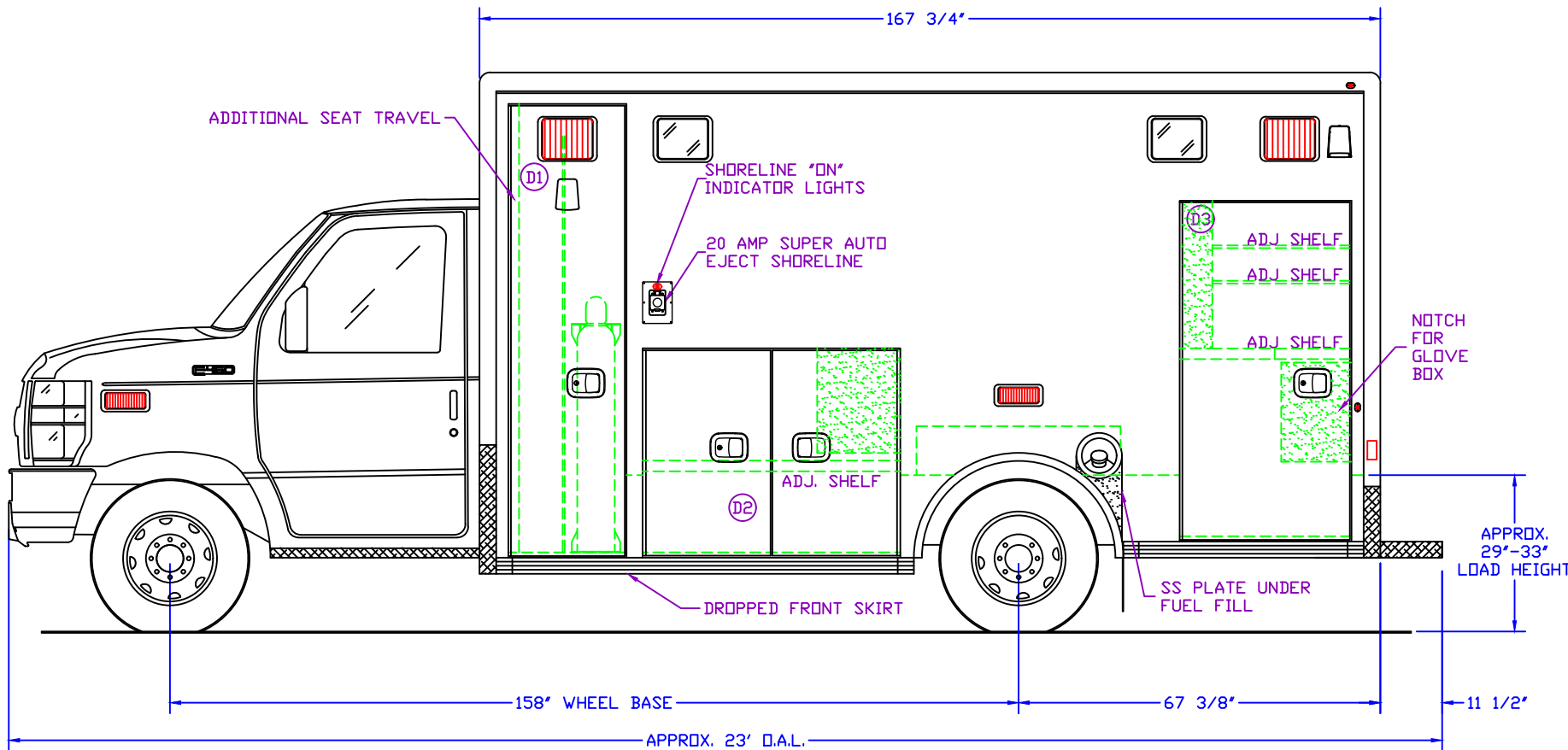

STREET SIDE

COMPT.	INTERIOR HEIGHT	PASS-THRU HEIGHT	INTERIOR WIDTH	PASS-THRU WIDTHS	DEPTH	DESCRIPTION
D1	82 1/2"	82 1/2"	19 1/2"	17"	19 1/4"	O2 STORAGE
D2	37"	37"	47 1/2"	40"	17 3/4"	STORAGE
D3	61 1/2"	61 1/2"	32 1/2"	27"	16 3/4"	IS/OS STORAGE

DRAWING NO:  
**5294-SDE**

DRAWN BY: J.P.

DATE: 4/29/22

SCALE: 1"=32"

REVISION(S):

5/27/22



**LIFE LINE**  
EMERGENCY VEHICLES

1 Life Line Dr.  
Sumner, IA 50674

P.O. Box 299  
Sumner, IA 50674

NOTE: SHIP SPARE TIRE LOOSE

FOR DRAWING APPROVAL

APPROVED BY: \_\_\_\_\_

TITLE: \_\_\_\_\_

DATE: \_\_\_\_\_

167" TYPE III SUPERLINER, 72" HEADROOM  
FOR GORMAN EMERGENCY VEHICLES DEMO

DIMENSIONS SHOWN ARE APPROXIMATE AND MAY CHANGE DURING THE CONSTRUCTION PROCESS. PRINTS ARE FOR GRAPHICAL REPRESENTATION ONLY AND NOT FOR DESIGN PURPOSES.

Tolerances:



Ang. Tol: ±1°  
Dim. Tol: ±1/16"

THIS DRAWING IS THE PROPERTY OF LIFE LINE EMERGENCY VEHICLES, WHICH CLAIMS PROPRIETARY RIGHTS IN THE MATERIAL DISCLOSED. IT IS ISSUED IN CONFIDENCE FOR ENGINEERING INFORMATION ONLY AND MAY NOT BE COPIED OR USED FOR MANUFACTURING OF ANYTHING SHOWN WITHOUT SPECIFIC WRITTEN PERMISSION OF LIFE LINE EMERGENCY VEHICLES.

8 7 6 5 4 3 2 1

D

C

B

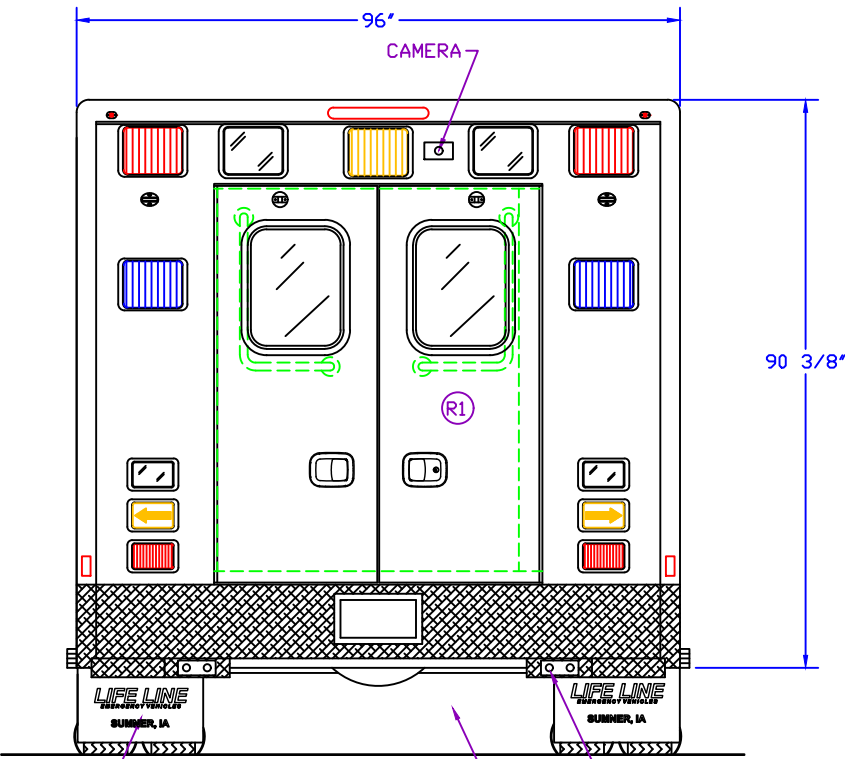

REAR MUD FLAPS WITH METAL STABILIZERS

RUBBER DOCK BUMPERS

TOW HOOKS MOUNTED UNDER BUMPER

REAR

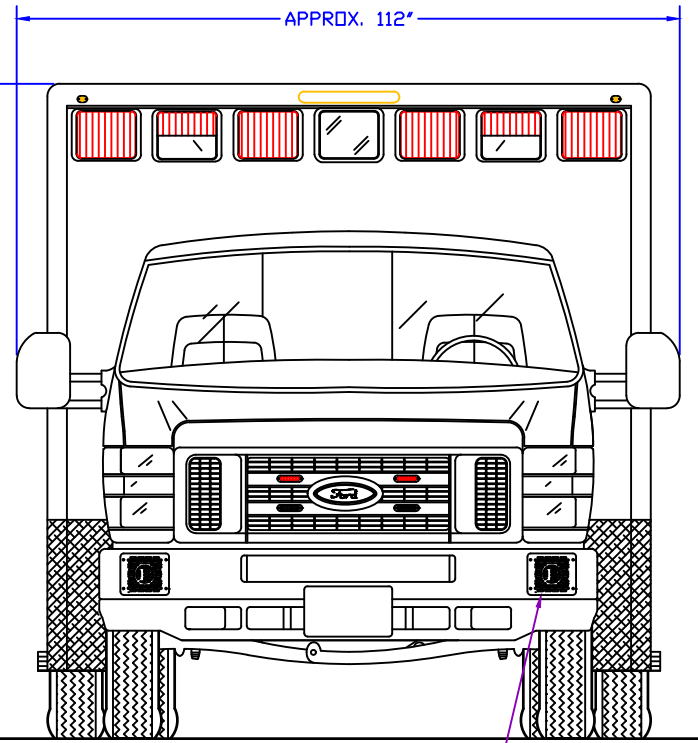

FRONT

\*HIDDEN SWITCH FOR POWER DOOR LOCKS (UNLOCK ONLY)

COMPT.	INTERIOR HEIGHT	PASS-THRU HEIGHT	INTERIOR WIDTH	PASS-THRU WIDTHS	DEPTH	DESCRIPTION
R1	72 1/4"	60"	48"	48"	---	REAR ENTRANCE

DRAWING NO:  
**5294-SDE**

DRAWN BY: J.P.

DATE: 4/29/22

SCALE: 1"=32"

REVISION(S):  
5/27/22

**LIFE LINE**  
EMERGENCY VEHICLES

1 Life Line Dr. P.O. Box 299  
Sumner, IA 50674 Sumner, IA 50674

DIMENSIONS SHOWN ARE APPROXIMATE AND MAY CHANGE DURING THE CONSTRUCTION PROCESS. PRINTS ARE FOR GRAPHICAL REPRESENTATION ONLY AND NOT FOR DESIGN PURPOSES.

Tolerances:  
  
 Ang. Tol: ±1°  
 Dim. Tol: ±1/16"

THIS DRAWING IS THE PROPERTY OF LIFE LINE EMERGENCY VEHICLES, WHICH CLAIMS PROPRIETARY RIGHTS IN THE MATERIAL DISCLOSED. IT IS ISSUED IN CONFIDENCE FOR ENGINEERING INFORMATION ONLY AND MAY NOT BE COPIED OR USED FOR MANUFACTURING OF ANYTHING SHOWN WITHOUT SPECIFIC WRITTEN PERMISSION OF LIFE LINE EMERGENCY VEHICLES.

FOR DRAWING APPROVAL

APPROVED BY: \_\_\_\_\_

TITLE: \_\_\_\_\_

DATE: \_\_\_\_\_

167" TYPE III SUPERLINER, 72" HEADROOM  
FOR GORMAN EMERGENCY VEHICLES DEMO

8 7 6 5 4 3 2 1

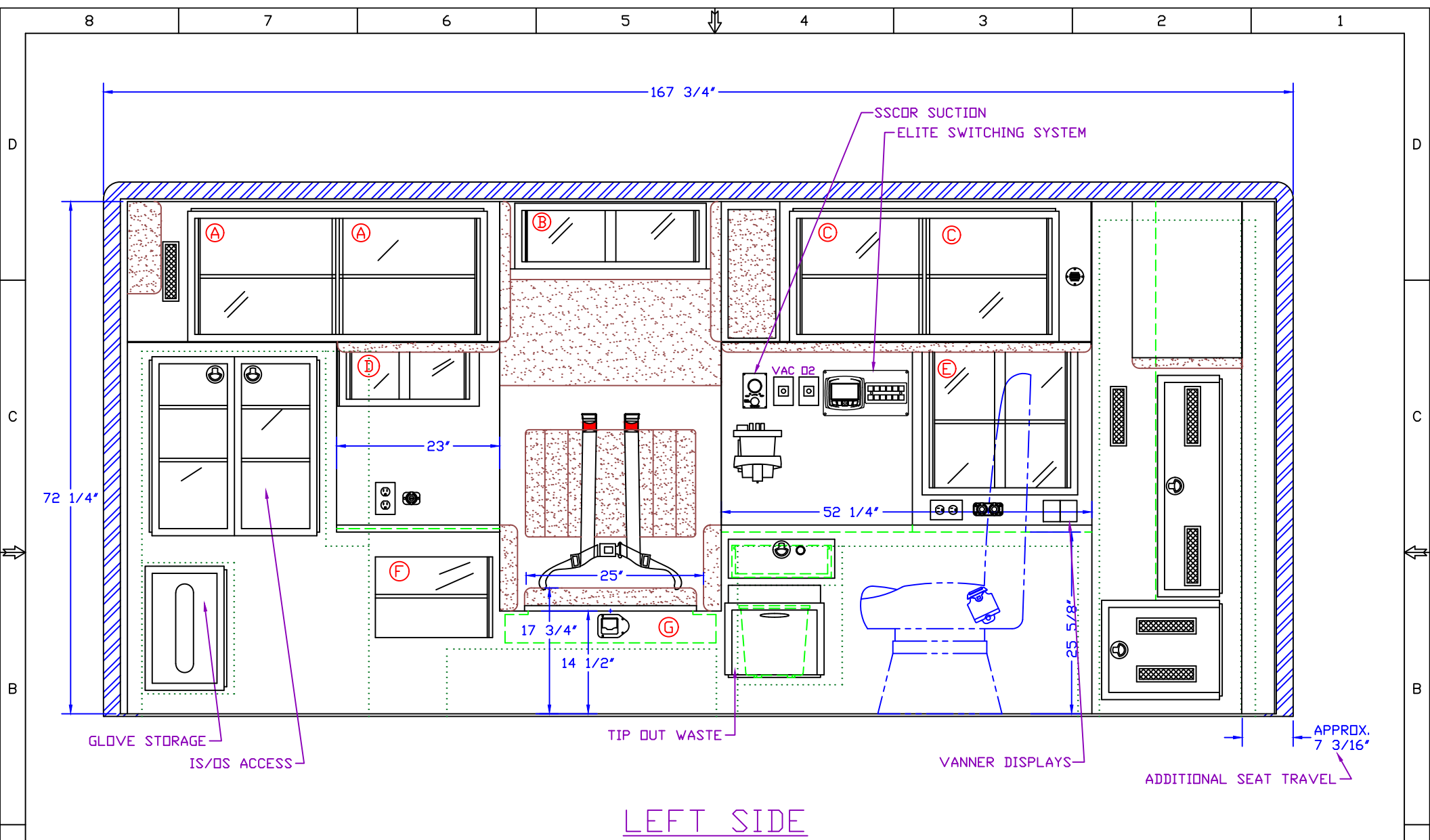

LEFT SIDE

CABINET	INTERIOR HEIGHT	INTERIOR WIDTH	INTERIOR DEPTH	DESCRIPTION	DOOR STYLE
A	18 3/4"	20 1/4"	16 3/4"	STORAGE	SPEED LOAD W/ POSITIVE LATCHES
B	8 1/4"	26"	8"	STORAGE	SLIDING POLYCARBONATE
C	18 3/4"	18 1/4"	14 3/4"	STORAGE	SPEED LOAD W/ POSITIVE LATCHES
D	8"	19"	6"	STORAGE	SLIDING POLYCARBONATE
E	17 1/2"	10"	6"	STORAGE	SLIDING POLYCARBONATE
F	14 5/8"	16 1/2"	18 1/4"	STORAGE	SINGLE SLIDING POLY POCKET
G	4"	29 3/4"	18 3/4"	STORAGE	TOP HINGED LID

DRAWING NO:  
**5294-SDI**

DRAWN BY: J.P.  
DATE: 4/29/22  
SCALE: 1"=19.5"  
REVISION(S):  
5/27/22

**LIFE LINE**  
EMERGENCY VEHICLES  
1 Life Line Dr. P.O. Box 299  
Sumner, IA 50674 Sumner, IA 50674

DIMENSIONS SHOWN ARE APPROXIMATE AND MAY CHANGE DURING THE CONSTRUCTION PROCESS. PRINTS ARE FOR GRAPHICAL REPRESENTATION ONLY AND NOT FOR DESIGN PURPOSES.

Tolerances:  
  
 Ang. Tol: ±1"  
 Dim. Tol: ±1"

THIS DRAWING IS THE PROPERTY OF LIFE LINE EMERGENCY VEHICLES, WHICH CLAIMS PROPRIETARY RIGHTS IN THE MATERIAL DISCLOSED. IT IS ISSUED IN CONFIDENCE FOR ENGINEERING INFORMATION ONLY AND MAY NOT BE COPIED OR USED FOR MANUFACTURING OF ANYTHING SHOWN WITHOUT SPECIFIC WRITTEN PERMISSION OF LIFE LINE EMERGENCY VEHICLES.

FOR DRAWING APPROVAL  
 APPROVED BY: \_\_\_\_\_  
 TITLE: \_\_\_\_\_  
 DATE: \_\_\_\_\_

167" TYPE III SUPERLINER, 72" HEADROOM  
 FOR GORMAN EMERGENCY VEHICLES DEMO

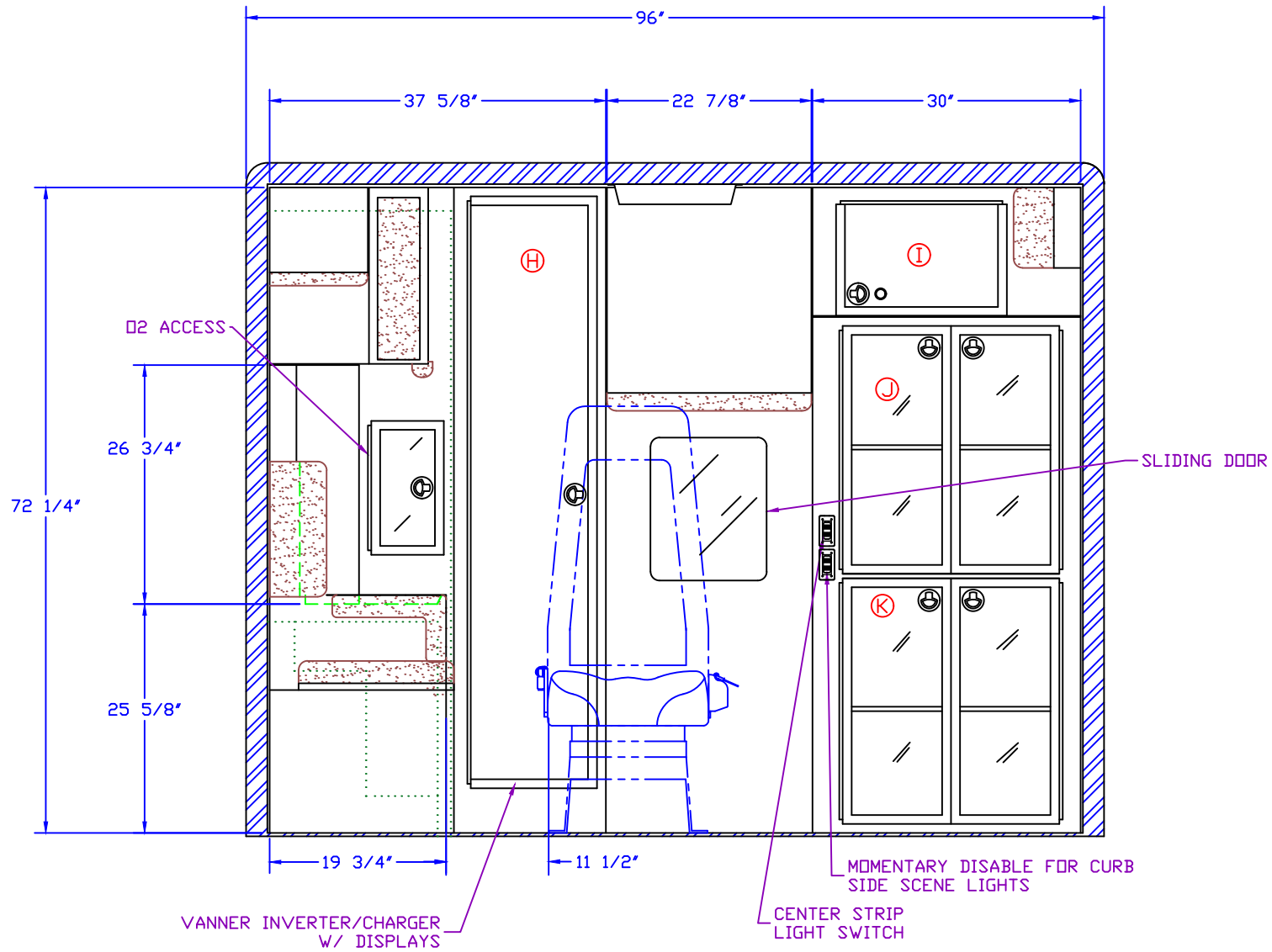

FRONT VIEW

CABINET	INTERIOR HEIGHT	INTERIOR WIDTH	INTERIOR DEPTH	DESCRIPTION	DOOR STYLE
H	71 1/4"	16"	8"	ELECTRICAL	SIDE HINGED SOLID DOOR
I	13 3/8"	18 1/4"	22"	LOCKING STORAGE	TOP HINGED SOLID DOOR
J	28 3/4"	26"	22"	IS/OS STORAGE	DUAL SIDE HINGED FRAMED POLY
K	27 3/4"	26"	22"	IS/OS STORAGE	DUAL SIDE HINGED FRAMED POLY

DRAWING NO: **5294-SDI**  
 DRAWN BY: J.P.  
 DATE: 4/29/22  
 SCALE: 1"=19.5"  
 REVISION(S):  
 5/27/22

**LIFE LINE**  
**EMERGENCY VEHICLES**  
 1 Life Line Dr. P.O. Box 299  
 Sumner, IA 50674 Sumner, IA 50674

FOR DRAWING APPROVAL  
 APPROVED BY: \_\_\_\_\_  
 TITLE: \_\_\_\_\_  
 DATE: \_\_\_\_\_

167" TYPE III SUPERLINER, 72" HEADROOM  
 FOR GORMAN EMERGENCY VEHICLES DEMO

DIMENSIONS SHOWN ARE APPROXIMATE AND MAY CHANGE DURING THE CONSTRUCTION PROCESS. PRINTS ARE FOR GRAPHICAL REPRESENTATION ONLY AND NOT FOR DESIGN PURPOSES.

Tolerances:  
  
 Third Angle Projection (ANSI)  
 Ang. Tol: ±1°  
 Dim. Tol: ±1"

THIS DRAWING IS THE PROPERTY OF LIFE LINE EMERGENCY VEHICLES, WHICH CLAIMS PROPRIETARY RIGHTS IN THE MATERIAL DISCLOSED. IT IS ISSUED IN CONFIDENCE FOR ENGINEERING INFORMATION ONLY AND MAY NOT BE COPIED OR USED FOR MANUFACTURING OF ANYTHING SHOWN WITHOUT SPECIFIC WRITTEN PERMISSION OF LIFE LINE EMERGENCY VEHICLES.

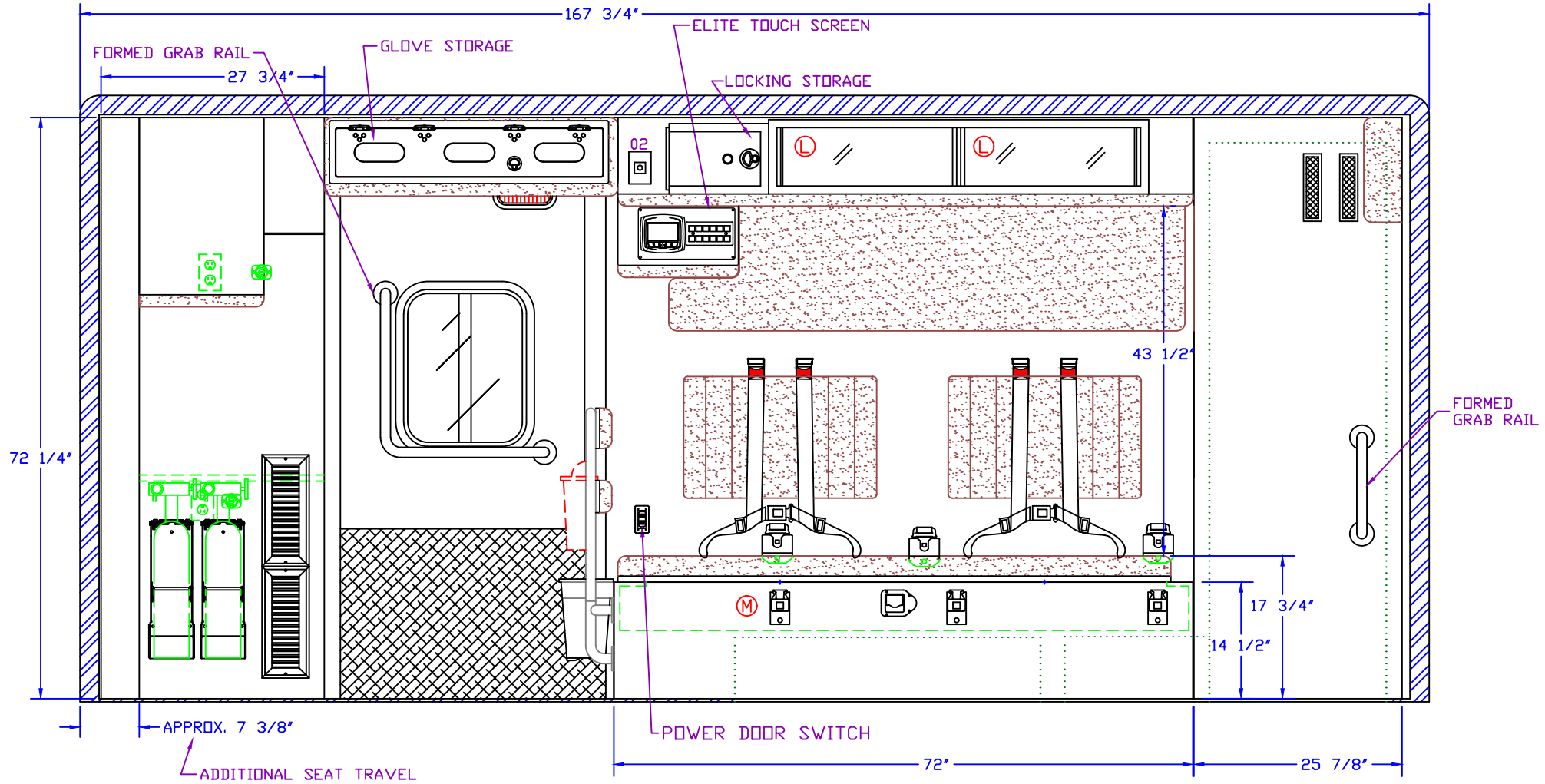

RIGHT SIDE

CABINET	INTERIOR HEIGHT	INTERIOR WIDTH	INTERIOR DEPTH	DESCRIPTION	DOOR STYLE
L	8 1/4"	22 3/4"	8"	STORAGE	SPEED LOAD W/ POSITIVE LATCHES
M	5 7/16"	70 3/4"	20 1/4"	STORAGE	TOP HINGED LID

**DRAWING NO:** 5294-SDI  
**DRAWN BY:** J.P.  
**DATE:** 4/29/22  
**SCALE:** 1"=19.5"  
**REVISION(S):**  
 5/9/22 - 5/27/22

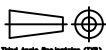

**LIFE LINE**  
**EMERGENCY VEHICLES**  
 1 Life Line Dr. P.O. Box 299  
 Sumner, IA 50674 Sumner, IA 50674

**Tolerances:**  
  
 Third Angle Projection (ANSI)  
 Ang. Tol: ±1°  
 Dim. Tol: ±1/16"

**THIS DRAWING IS THE PROPERTY OF LIFE LINE EMERGENCY VEHICLES, WHICH CLAIMS PROPRIETARY RIGHTS IN THE MATERIAL DISCLOSED. IT IS ISSUED IN CONFIDENCE FOR ENGINEERING INFORMATION ONLY AND MAY NOT BE COPIED OR USED FOR MANUFACTURING OF ANYTHING SHOWN WITHOUT SPECIFIC WRITTEN PERMISSION OF LIFE LINE EMERGENCY VEHICLES.**

**FOR DRAWING APPROVAL**  
 APPROVED BY: \_\_\_\_\_  
 TITLE: \_\_\_\_\_  
 DATE: \_\_\_\_\_

**167" TYPE III SUPERLINER, 72" HEADROOM  
 FOR GORMAN EMERGENCY VEHICLES DEMO**

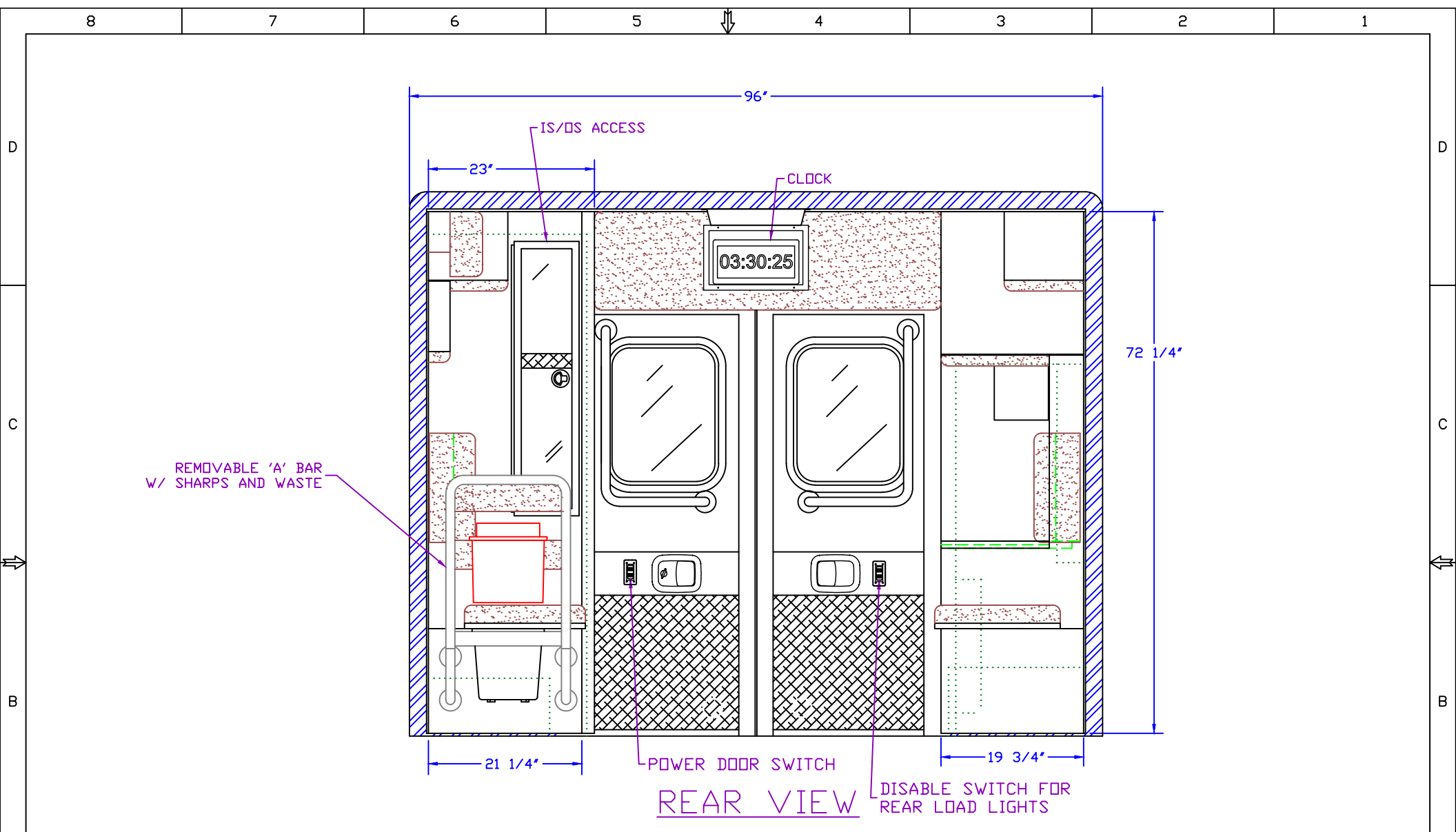

CABINET	INTERIOR HEIGHT	INTERIOR WIDTH	INTERIOR DEPTH	DESCRIPTION	DOOR STYLE

**DRAWING NO:** 5294-SDI

**DRAWN BY:** J.P.

**DATE:** 4/29/22

**SCALE:** 1"=19.5"

**REVISION(S):** ---



**LIFE LINE**  
**EMERGENCY VEHICLES**  
 1 Life Line Dr. P.O. Box 299  
 Sumner, IA 50674 Sumner, IA 50674

DIMENSIONS SHOWN ARE APPROXIMATE AND MAY CHANGE DURING THE CONSTRUCTION PROCESS. PRINTS ARE FOR GRAPHICAL REPRESENTATION ONLY AND NOT FOR DESIGN PURPOSES.

Tolerances:  
  
 Third Angle Projection (ANSI)  
 Ang. Tol: ±1°  
 Dim. Tol: ±.1"

THIS DRAWING IS THE PROPERTY OF LIFE LINE EMERGENCY VEHICLES, WHICH CLAIMS PROPRIETARY RIGHTS IN THE MATERIAL DISCLOSED. IT IS ISSUED IN CONFIDENCE FOR ENGINEERING INFORMATION ONLY AND MAY NOT BE COPIED OR USED FOR MANUFACTURING OF ANYTHING SHOWN WITHOUT SPECIFIC WRITTEN PERMISSION OF LIFE LINE EMERGENCY VEHICLES.

**FOR DRAWING APPROVAL**  
 APPROVED BY: \_\_\_\_\_  
 TITLE: \_\_\_\_\_  
 DATE: \_\_\_\_\_

**167" TYPE III SUPERLINER, 72" HEADROOM  
 FOR GORMAN EMERGENCY VEHICLES DEMO**

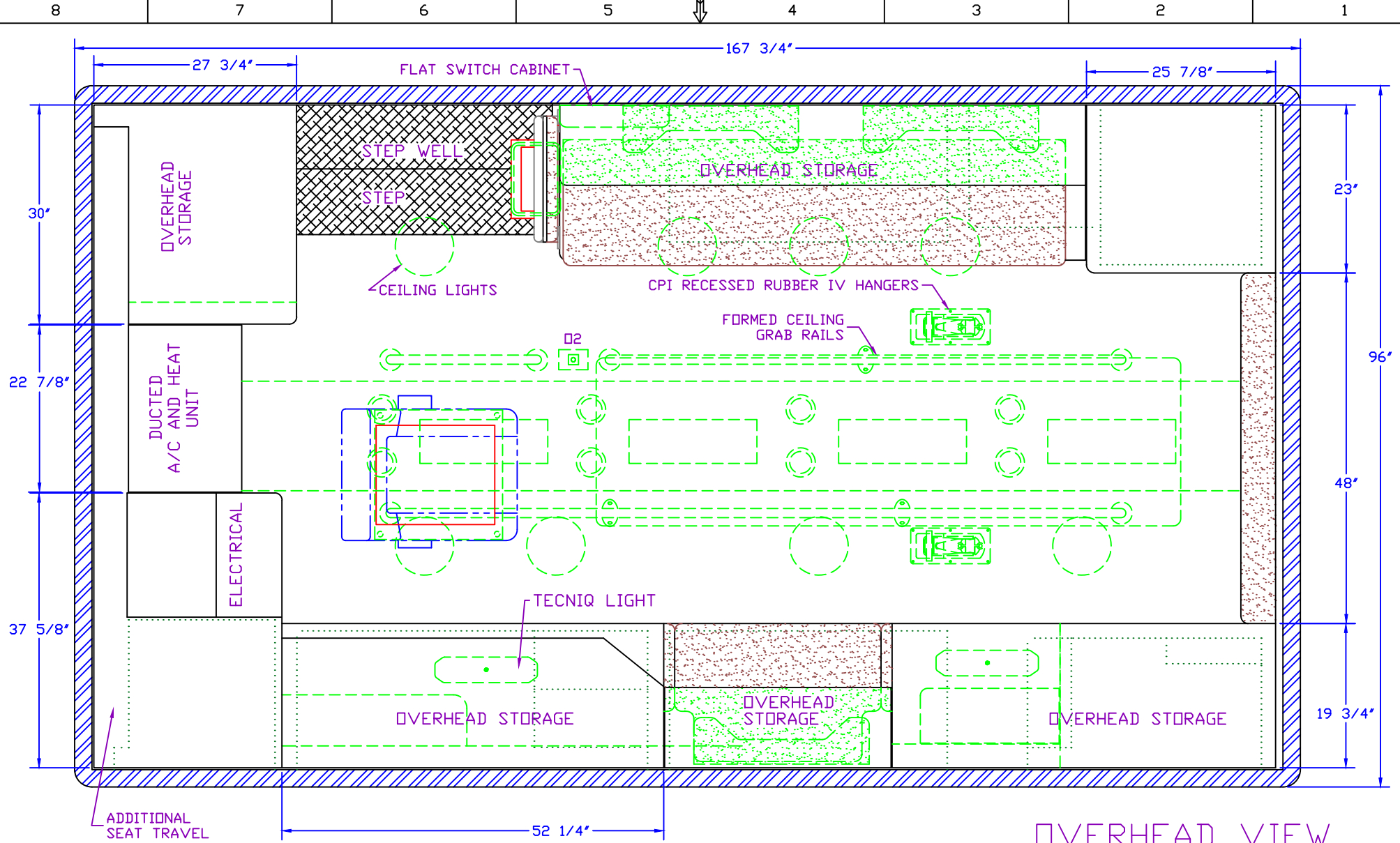

OVERHEAD VIEW

CABINET	INTERIOR HEIGHT	INTERIOR WIDTH	INTERIOR DEPTH	DESCRIPTION	DOOR STYLE

DRAWING NO: **5294-SDI**  
 DRAWN BY: J.P.  
 DATE: 4/29/22  
 SCALE: 1"=19.5"  
 REVISION(S):  
 5/27/22



**LIFE LINE**  
**EMERGENCY VEHICLES**  
 1 Life Line Dr. P.O. Box 299  
 Sumner, IA 50674 Sumner, IA 50674

DIMENSIONS SHOWN ARE APPROXIMATE AND MAY CHANGE DURING THE CONSTRUCTION PROCESS. PRINTS ARE FOR GRAPHICAL REPRESENTATION ONLY AND NOT FOR DESIGN PURPOSES.

Tolerances:  
  
 Ang. Tol: ±1"  
 Dim. Tol: ±1"

THIS DRAWING IS THE PROPERTY OF LIFE LINE EMERGENCY VEHICLES, WHICH CLAIMS PROPRIETARY RIGHTS IN THE MATERIAL DISCLOSED. IT IS ISSUED IN CONFIDENCE FOR ENGINEERING INFORMATION ONLY AND MAY NOT BE COPIED OR USED FOR MANUFACTURING OF ANYTHING SHOWN WITHOUT SPECIFIC WRITTEN PERMISSION OF LIFE LINE EMERGENCY VEHICLES.

FOR DRAWING APPROVAL  
 APPROVED BY: \_\_\_\_\_  
 TITLE: \_\_\_\_\_  
 DATE: \_\_\_\_\_

167" TYPE III SUPERLINER, 72" HEADROOM  
 FOR GORMAN EMERGENCY VEHICLES DEMO



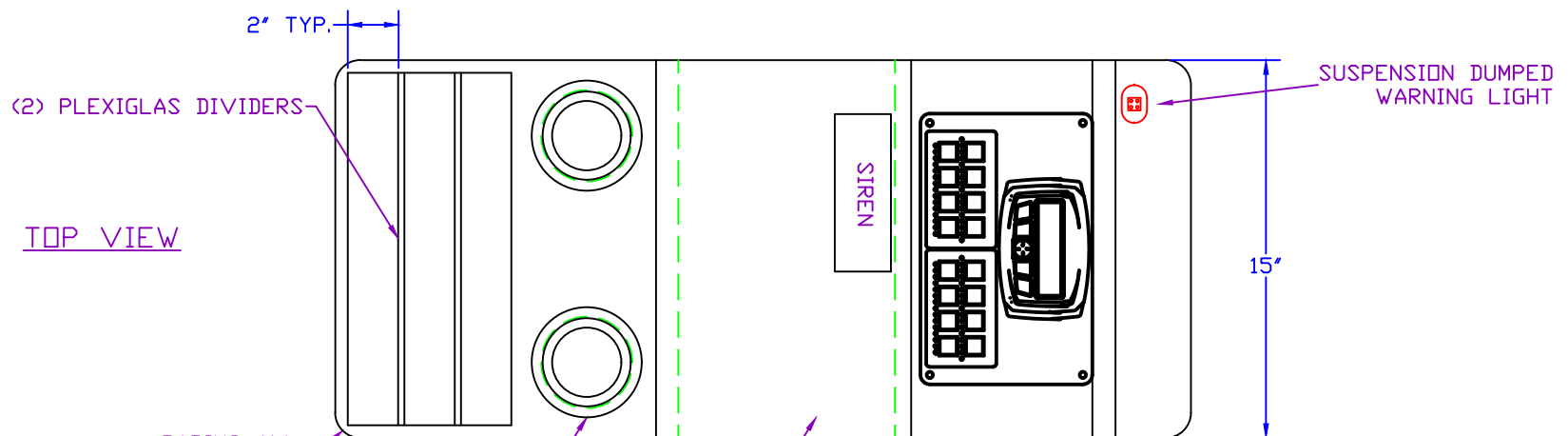

TOP VIEW

(2) PLEXIGLAS DIVIDERS  
 2' TYP.  
 RADIUS ALL 4 CORNERS  
 LARGE CUP HOLDERS  
 REMOVEABLE PANEL  
 SIREN  
 SUSPENSION DUMPED WARNING LIGHT  
 15'

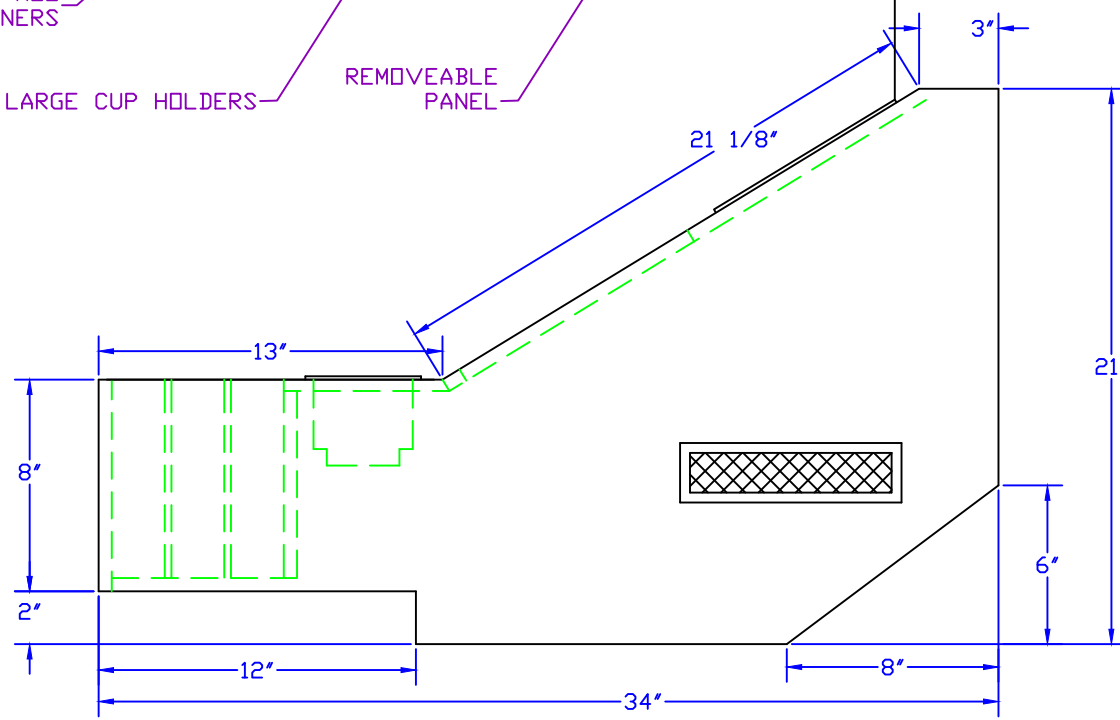

SIDE VIEW

DRAWING NO: 5294-CON  
 DRAWN BY: J.P.  
 DATE: 4/29/22  
 SCALE: NTS  
 REVISION(S): 5/27/22



**LIFE LINE**  
 EMERGENCY VEHICLES  
 1 Life Line Dr. P.O. Box 299  
 Sumner, IA 50674 Sumner, IA 50674

DIMENSIONS SHOWN ARE APPROXIMATE AND MAY CHANGE DURING THE CONSTRUCTION PROCESS. PRINTS ARE FOR GRAPHICAL REPRESENTATION ONLY AND NOT FOR DESIGN PURPOSES.

Tolerances:  
  
 Ang. Tol: ±1°  
 Dim. Tol: ±1/16"

THIS DRAWING IS THE PROPERTY OF LIFE LINE EMERGENCY VEHICLES, WHICH CLAIMS PROPRIETARY RIGHTS IN THE MATERIAL DISCLOSED. IT IS ISSUED IN CONFIDENCE FOR ENGINEERING INFORMATION ONLY AND MAY NOT BE COPIED OR USED FOR MANUFACTURING OF ANYTHING SHOWN WITHOUT SPECIFIC WRITTEN PERMISSION OF LIFE LINE EMERGENCY VEHICLES.

FOR DRAWING APPROVAL  
 APPROVED BY: \_\_\_\_\_  
 TITLE: \_\_\_\_\_  
 DATE: \_\_\_\_\_

167" TYPE III SUPERLINER, 72" HEADROOM  
 FOR GORMAN EMERGENCY VEHICLES DEMO